

KRISMA

ASAHARA SIGEAKI 1997



COLLECTION

SISTEMA DI FARETTI ORIENTABILI, SINGOLI O DOPPI, PER LAMPADE ALOGENE A TENSIONE DI RETE E AD ALOGENURI METALLICI, DA BINARIO TRIFASE, SEMINCASSO, PARETE-PLAFONE. LE ASTINE CROMATE, FISSATE AL CORPO, CONSENTONO IL MONTAGGIO DI UNA SERIE DI ACCESSORI: ANELLI, VETRI DIFFUSORE E SCHERMI.

SYSTEM OF HALOGEN OR METAL HALIDE SINGLE OR DOUBLE ADJUSTABLE SPOTLIGHTS. THREE-CIRCUIT RAIL TRACK MOUNTED, SEMIRECESSED OR WALL-CEILING MOUNTING. TWO CHROMED STEMS, FIXED TO THE BODY ALLOW THE MOUNTING OF VARIOUS ACCESSORIES: RINGS, GLASS DIFFUSERS AND BAFFLES.





SYSTEM MIT AUSRICHTBAREN STRAHLERN, 1-FACH ODER 2-FACH, FÜR HOCHVOLT HALOGENLAMPEN UND METTALDAMPFLAMPEN, FÜR DREIPHASENSCHIENE, HALBEINBAU, WAND/DECKE. ZWEI SEITLICHE CHROMSTANGEN ERMÖGLICHEN DIE BEFESTIGUNG OPTIONALER ZUBEHÖRTEILE: BLENDSCHUTZRINGE, SCHIRME UND GLASDIFFUSOREN.

SYSTÈME DE SPOTS ORIENTABLES, UN OU DEUX RÉFLECTEURS, POUR LAMPES HALOGÈNES ET À IODURES MÉTALLIQUES. DISPONIBLES POUR RAIL TRIPHASÉ, EN SEMI-ENCASTRÉS, APPLIQUES-PLAFONNIERS. LES TIGES CHROMÉES, FIXÉES AU CORPS, PERMETTENT LE MONTAGE D'UNE SÉRIE D'ACCESSOIRES: ANNEAUX, VERRES DIFFUSEURS ET ÉCRANS.

SYSTEEM VAN EEN/DUBBELE RICHTBARE SPOTS VOOR DRIEFAZIGE RAIL, HALF INBOUW-, WAND/PLAFOND-, STAANLAMPEN. VOORZIEN VOOR HALOGEENLAMPEN EN METAALACHTIGE JODIDE GLOEILAMP. 2 CHROOMSTANGEN ZIJN AAN HET TOESTEL BEVESTIGD OM ACCESSOIRES TE MONTEREN: RING, DIFFUSORGLAS EN SCHERM.

SISTEMA DE FOCOS ORIENTABLES, INDIVIDUALES O DOBLES, PARA BOMBILLAS ALOGENAS A TENSION DE RED Y ALOGENUROS METALICOS, PARA CARRIL TRIFASICO, SEMIEMPOTRADO, PARED-TECHO. LAS BARRITAS CROMADAS, FIJADAS AL CUERO, CONSIENTEN EL MONTAJE DE UNA SERIO DE ACCESORIOS. ANILLOS, CRISTAL DIFUSOR Y PANTALLA DE PROTECCION.



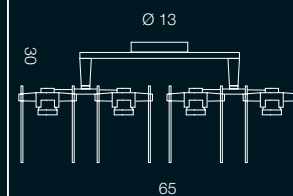
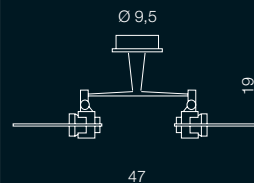
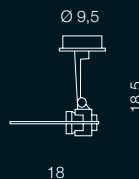
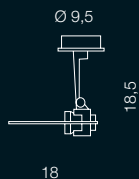
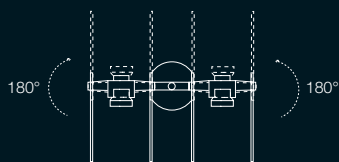

NOME / NAME	KRISMA H B	KRISMA IM 70 AR	KRISMA H DOPPIO B	KRISMA H QUATTRO B
DESCRIZIONE / DESCRIPTION	LAMPADA DA PARETE-PLAFONE	LAMPADA DA PARETE-PLAFONE	LAMPADA DA PARETE-PLAFONE	LAMPADA DA PARETE-PLAFONE
	ALOGENA	IODURI METALLICI	ALOGENA	ALOGENA
	WALL-CEILING LAMP	WALL-CEILING LAMP	WALL-CEILING LAMP	WALL-CEILING LAMP
	HALOGEN	METAL HALIDE	HALOGEN	HALOGEN
CODICE / CODE	01810	01803	01806	01807
PORTALAMPADA / LAMP HOLDERS	E 27	E 27	E 27	E 27
LAMPADINA / BULBS				
POTENZA / POWER	MAX 100W - PAR 30	70W - PAR 30	2 X MAX100W - PAR 30	4 X MAX 100W - PAR 30
TENSIONE / TENSION	230V	230V	230V	230V
ILCOS	HEGPAR	MR	HEGPAR	HEGPAR
ALIMENTATORE / CONTROL GEAR	-	REMOTO ESCLUSO	-	-
		REMOTE EXCLUDED		
CLASSE IP / IP CLASS	IP 20	IP 20	IP 20	IP 20
CLASSE ISOLAMENTO / INSULATING CLASS	II	II	II	I
PESO NETTO KG / KG NET WEIGHT	0,400	0,400	0,650	2,100
FINITURE / FINISH				
BIANCO OPACO / MATT WHITE	01	01	01	01
GRIGIO ARGENTO OPACO / MATT SILVER GREY	19	19	19	19
BIANCO-CROMO / CHROME-WHITE	63	63	63	63
MARCHI / MARKS	IMQ - CE - F	IMQ - CE - F	IMQ - CE - F	IMQ - CE - F
ACCESSORI / ACCESSORIES	VEDI PAG. 264 / SEE PAGE 264	VEDI PAG. 264 / SEE PAGE 264	VEDI PAG. 264 / SEE PAGE 264	VEDI PAG. 264 / SEE PAGE 264
INFO	CON BASE / WITH BASE	CON BASE / WITH BASE	CON BASE DOUBLE SPOT, WITH BASE	CON BASE FOUR SPOTS, WITH BASE

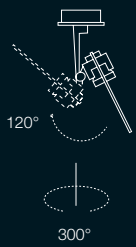







NOME / NAME	KRISMA H B/T	KRISMA H DOPPIO B/T	KIT SUPPORTO PARETE
DESCRIZIONE / DESCRIPTION	LAMPADA DA PARETE-PLAFONE	LAMPADA DA PARETE-PLAFONE	ACCESSORIO PER APPLICAZIONE A PARETE
	ALOGENA	ALOGENA	ACCESSORY FOR WALL BEARING SUPPORT
	WALL-/CEILING LAMP, HALOGEN	WALL /CEILING LAMP, HALOGEN	
CODICE / CODE	01860	01862	87918
PORTALAMPADA / LAMP HOLDERS	E 27	E 27	
LAMPADINA / BULBS			
POTENZA / POWER	MAX 100W - PAR 30	2 X MAX 100W PAR 30	
TENSIONE / TENSION	230V	230V	
ILCOS	HEGPAR	HEGPAR	
ALIMENTATORE / CONTROL GEAR	-	--	
CLASSE IP / IP CLASS	IP 20	IP 20	
CLASSE ISOLAMENTO / INSULATING CLASS	II	II	
PESO NETTO KG / KG NET WEIGHT	0,600	0,900	
FINITURE / FINISH			
BIANCO OPACO / MATT WHITE	01	01	-
GRIGIO ARGENTO OPACO / MATT SILVER GREY	19	19	-
CROMO LUCIDO / POLISHED CHROME	-	-	50
BIANCO-CROMO / CHROME-WHITE	63	63	-
MARCHI / MARKS	IMQ - CE - F	IMQ - CE - F	
ACCESSORI / ACCESSORIES	VEDI PAG. 264 / SEE PAGE 264	VEDI PAG. 264 / SEE PAGE 264	

INFO

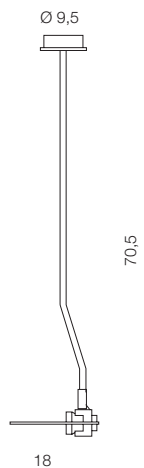
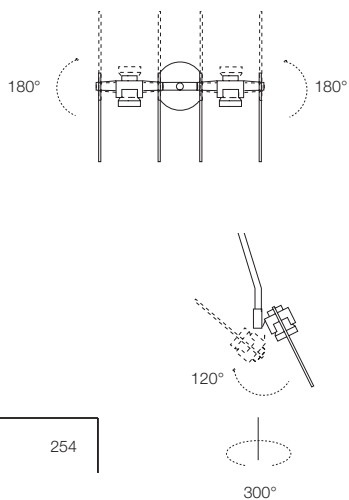

CON BASE E TIGE
WITH BASE AND STEM

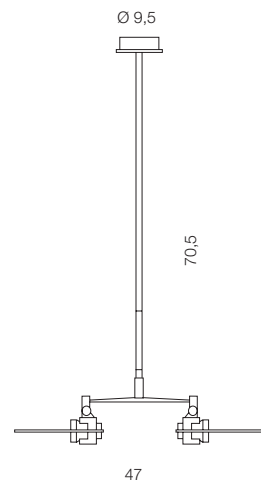

CON BASE E TIGE
DOUBLE SPOT,
WITH BASE AND STEM





NOME / NAME	KRISMA IM 70 SI	KRISMA IM 70 DOPPIO SI
DESCRIZIONE / DESCRIPTION	SEMINCASSO, IODURI METALLICI	SEMINCASSO, IODURI METALLICI
	SEMIRECESSED, METAL HALIDE	SEMIRECESSED DOUBLE, METAL HALIDE
CODICE / CODE	01863	01811
PORTALAMPADA / LAMP HOLDERS	E 27	E 27
LAMPADINA / BULBS		
POTENZA / POWER	70W - PAR 30	2 X 70W - PAR 30
TENSIONE / TENSION	230V	230V
ILCOS	MR	MR
ALIMENTATORE / CONTROL GEAR	REMOTO ESCL. / REMOTE EXCL.	REMOTO ESCL. / REMOTE EXCL.
CLASSE IP / IP CLASS	IP 20	IP 20
CLASSE ISOLAMENTO / INSULATING CLASS	II	II
PESO NETTO KG / KG NET WEIGHT	0,550	0,800
FINITURE / FINISH		
BIANCO OPACO / MATT WHITE	01	01
GRIGIO ARGENTO OPACO / MATT SILVER GREY	19	19
BIANCO-CROMO / CHROME-WHITE	63	63
MARCHI / MARKS	IMQ - CE - F	IMQ - CE - F
ACCESSORI / ACCESSORIES	VEDI PAG. 264 / SEE PAGE 264	VEDI PAG. 264 / SEE PAGE 264
INFO	MOLLE DI ANCORAGGIO ADATTABILI A DIVERSI SPESSORI DI CONTROSOFFITTO (MED. DISEGNO) ANCHORING SPRINGS SUITABLE FOR VARIOUS THICKNESSES OF THE SUSPENDED CEILING (SEE SKETCH)	MOLLE DI ANCORAGGIO ADATTABILI A DIVERSI SPESSORI DI CONTROSOFFITTO (MED. DISEGNO) ANCHORING SPRINGS SUITABLE FOR VARIOUS THICKNESSES OF THE SUSPENDED CEILING (SEE SKETCH)

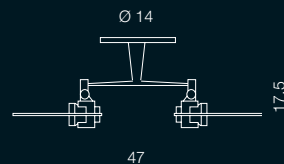
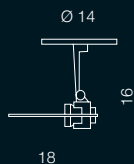
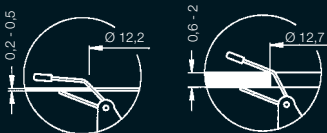

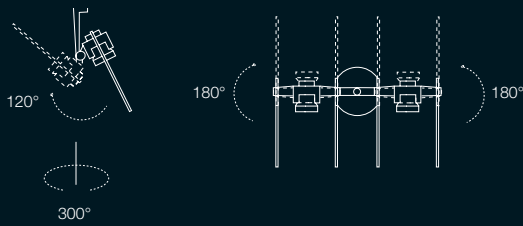





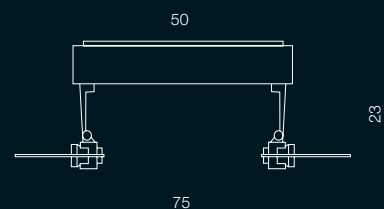
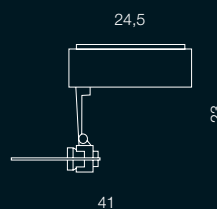
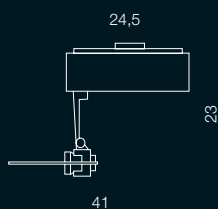

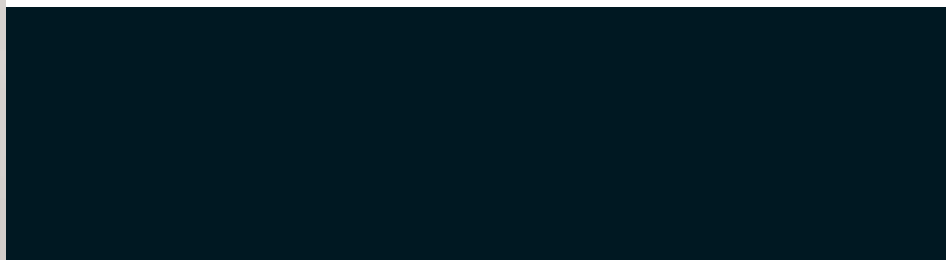
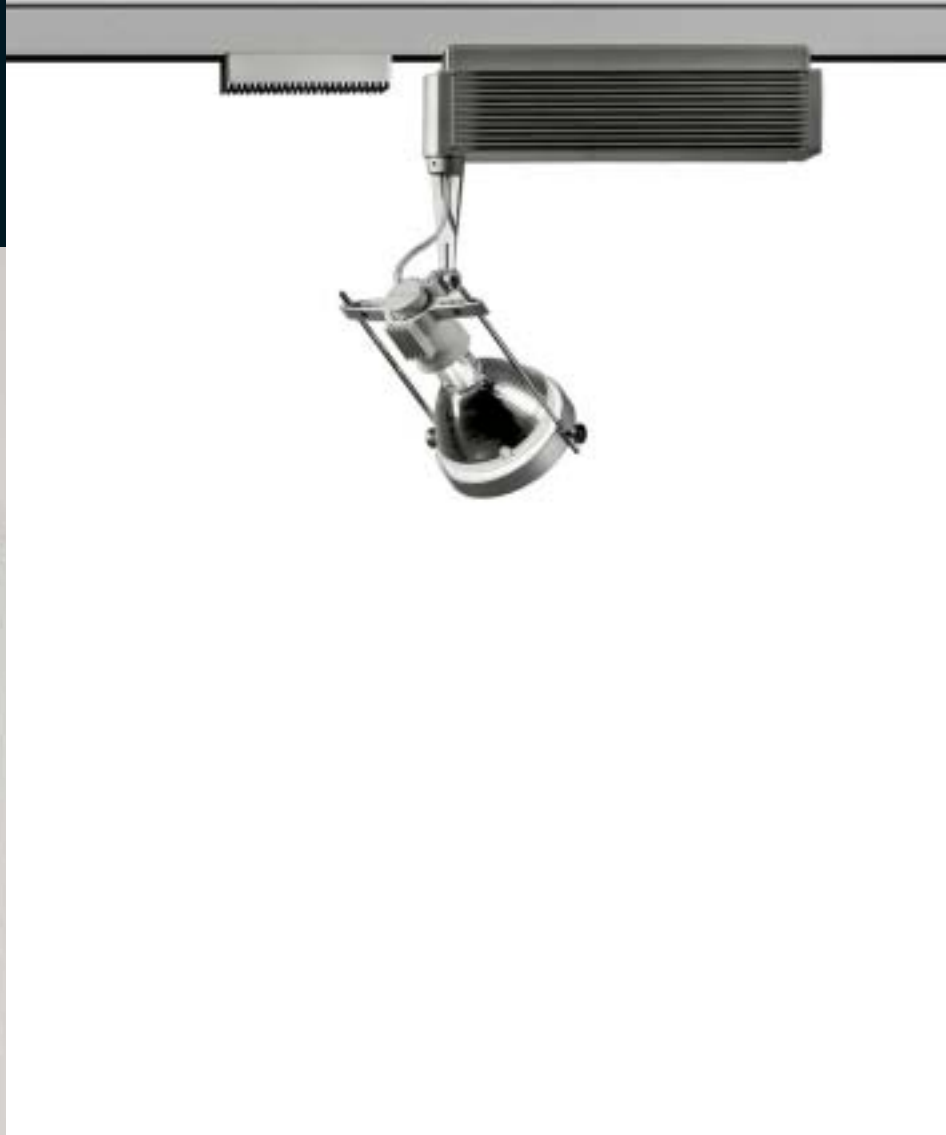
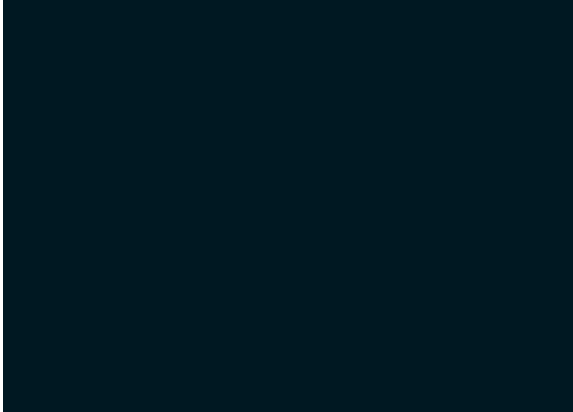
NOME / NAME	KRISMA IM 70 A	KRISMA IM 70 B	KRISMA IM 70 DOPPIO B
DESCRIZIONE / DESCRIPTION	LAMPADA DA BINARIO	LAMPADA DA PLAFONE-PARETE	LAMPADA DA PLAFONE-PARETE
	IODURI METALLICI	IODURI METALLICI	IODURI METALLICI
	RAIL LAMP, METAL HALIDE	CEILING-WALL LAMP, METAL HALIDE	CEILING-WALL LAMP, DOUBLE, METAL HALIDE
CODICE / CODE	01808	01815	01816
PORTALAMPADA / LAMPHOLDERS	E 27	E 27	E 27
LAMPADINA / BULBS			
POTENZA / POWER	70W - PAR 30	70W - PAR 30	2 X 70W - PAR 30
TENSIONE / TENSION	230V	230V	230V
ILCOS	MR	MR	MR
ALIMENTATORE / CONTROL GEAR	ELETTROMECCANICO INCLUSO	ELETTROMECCANICO INCLUSO	ELETTROMECCANICO INCLUSO
	ELECTROMECHANICAL INCLUDED	ELECTROMECHANICAL INCLUDED	ELECTROMECHANICAL INCLUDED
CLASSE IP / IP CLASS	I	I	I
CLASSE ISOLAMENTO / INSULATING CLASS	IP 20	IP 20	IP 20
PESO NETTO KG / KG NET WEIGHT	2,800	2,800	5,200
FINITURE / FINISH			
BIANCO OPACO / MATT WHITE	01	01	01
GRIGIO ARGENTO OPACO / MATT SILVER GREY	19	19	19
BIANCO-CROMO / CHROME-WHITE	63	63	63
MARCHI / MARKS	IMQ - CE - F	IMQ - CE - F	IMQ - CE - F
ACCESSORI / ACCESSORIES	VEDI PAG. 264 / SEE PAGE 264	VEDI PAG. 264 / SEE PAGE 264	VEDI PAG. 264 / SEE PAGE 264
INFO	CON ADATTATORE ELETTRICO SEPARATO / WITH SEPARATED ELECTRICAL ADAPTER COD. 01817 VERSIONE CON ALIMENTATORE ELETTRONICO CODE 01817 VERSION WITH ELECTRONIC CONTROL GEAR	CON BASE / WITH BASE COD. 01818 VERSIONE CON ALIMENTATORE ELETTRONICO CODE 01818 VERSION WITH ELECTRONIC CONTROL GEAR	CON BASE / WITH BASE





NOME / NAME	KRISMA H A	KRISMA H DOPPIO A	KRISMA H A/T	KRISMA H DOPPIO A/T
DESCRIZIONE / DESCRIPTION	LAMPADA DA BINARIO, ALOGENA	LAMPADA DA BINARIO, ALOGENA	LAMPADA DA BINARIO, ALOGENA	LAMPADA DA BINARIO, ALOGENA
	RAIL LAMP, HALOGEN	RAIL LAMP, DOUBLE, HALOGEN	RAIL LAMP, HALOGEN	RAIL LAMP, DOUBLE, HALOGEN
CODICE / CODE	01800	01804	01840	01845
PORTALAMPADA / LAMP HOLDERS	E 27	E 27	E 27	E 27
LAMPADINA / BULBS				
POTENZA / POWER	MAX 100W - PAR 30	2 X MAX 100W - PAR 30	MAX 100W - PAR 30	2 X MAX 100W - PAR 30
TENSIONE / TENSION	230V	230V	230V	230V
ILCOS	HEGPAR	HEGPAR	HEGPAR	HEGPAR
CLASSE IP / IP CLASS	IP 20	IP 20	IP 20	IP 20
CLASSE ISOLAMENTO / INSULATING CLASS	II	II	II	II
PESO NETTO KG / KG NET WEIGHT	0,400	0,600	0,650	0,800
FINITURE / FINISH				
BIANCO OPACO / MATT WHITE	01	01	01	01
GRIGIO ARGENTO OPACO / MATT SILVER GREY	19	19	19	19
BIANCO-CROMO / CHROME-WHITE	63	63	63	63
MARCHI / MARKS	IMQ - CE - F	IMQ - CE - F	IMQ - CE - F	IMQ - CE - F
ACCESSORI / ACCESSORIES	VEDI PAG. 264 / SEE PAGE 264	VEDI PAG. 264 / SEE PAGE 264	VEDI PAG. 264 / SEE PAGE 264	VEDI PAG. 264 / SEE PAGE 264

INFO	CON ADATTATORE BIANCO WITH WHITE ADAPTER	CON ADATTATORE BIANCO WITH WHITE ADAPTER	CON ADATTATORE BIANCO E TIGE WITH WHITE ADAPTER AND STEM	CON ADATTATORE BIANCO E TIGE WITH WHITE ADAPTER AND STEM
	COD. 01802 VERSIONE CON ADATTATORE NERO CODE 01802 VERSION WITH BLACK ADAPTER	COD. 01805 VERSIONE CON ADATTATORE NERO CODE 01805 VERSION WITH BLACK ADAPTER	COD. 01850 VERSIONE CON ADATTATORE NERO E TIGE CODE 01850 VERSION WITH BLACK ADAPTER AND STEM	COD. 01846 VERSIONE CON ADATTATORE NERO E TIGE CODE 01846 VERSION WITH BLACK ADAPTER AND STEM

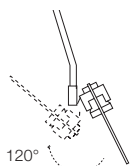
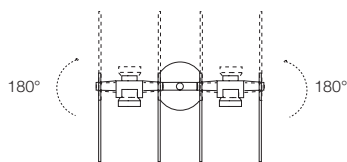

262

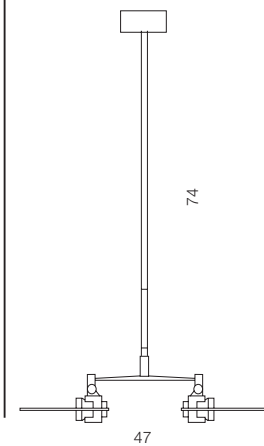
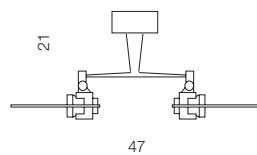
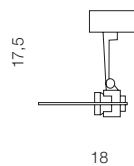



NOME / NAME	KRISMA . ANELLO	KRISMA . ANELLO C/V/D	KRISMA . SC	KRISMA . SC ASIMMETRICO
DESCRIZIONE / DESCRIPTION	ANELLO ANTI-ABBAGLIAMENTO	ANELLO ANTI-ABBAGLIAMENTO	SCHERMO CILINDRICO	SCHERMO CILINDRICO
	ANTI-GLARE RING	CON VETRO DIFFUSORE	TUBULAR BAFFLE	ASIMMETRICO
		ANTI-GLARE RING		TUBULAR ASYMMETRIC BAFFLE
		WITH GLASS DIFFUSER		
CODE / CODICE	01880	01875	01890	01885
FINITURE / FINISH				
BIANCO OPACO / MATT WHITE	01	01	01	01
GRIGIO ARGENTO OPACO / MATT SILVER GREY	19	19	19	19
CROMO LUCIDO / POLISHED CHROME	50	50	50	50

INFO	ANELLO IN ALLUMINIO RING OF ALUMINIUM	ANELLO IN ALLUMIINIO E VETRO SABBATO RING OF ALUMINIUM AND SANDBLAST GLASS	SCHERMO IN ALLUMINIO BAFFLE OF ALUMINIUM	SCHERMO IN ALLUMINIO BAFFLE OF ALUMINIUM
------	--	---	---	---

